

ronald gebhardt- landart - hellowood - eMRAK - getto tamás

ronald gebhardt

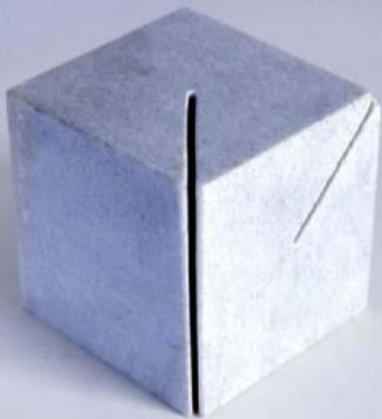





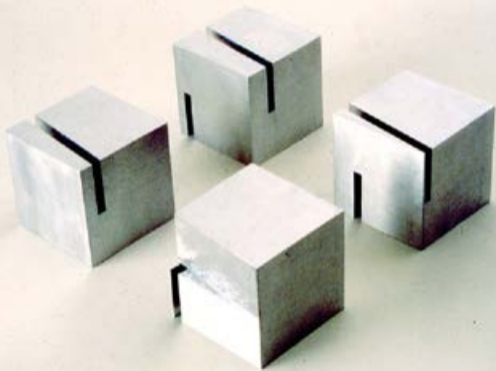











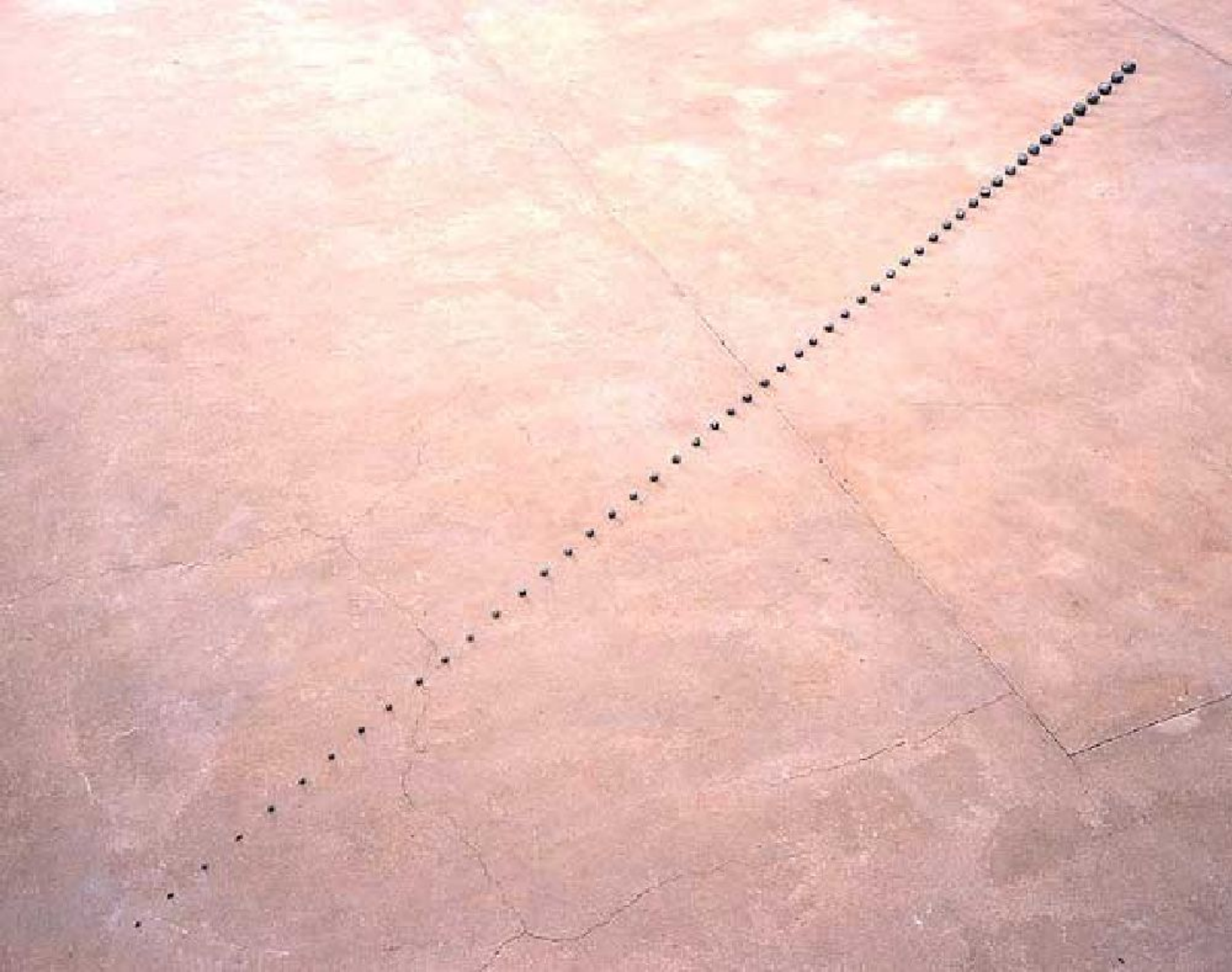

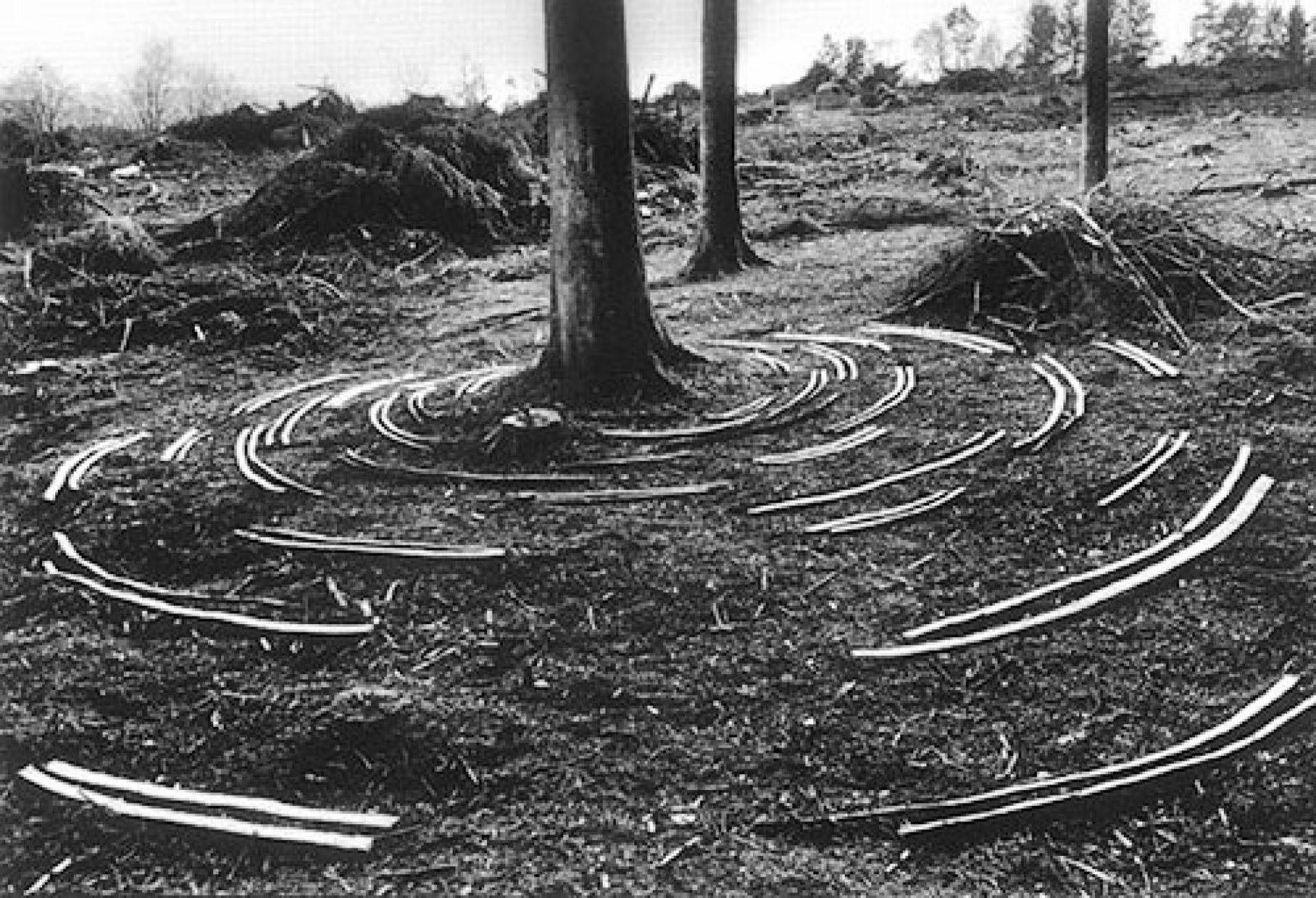































Bitte klicken, um
die Bilder vergrößert
zu sehen



















STRIJDOM VAN DER MERWE











18. kép. Christo: Völgyfüggöny (1971)







hellowood



































































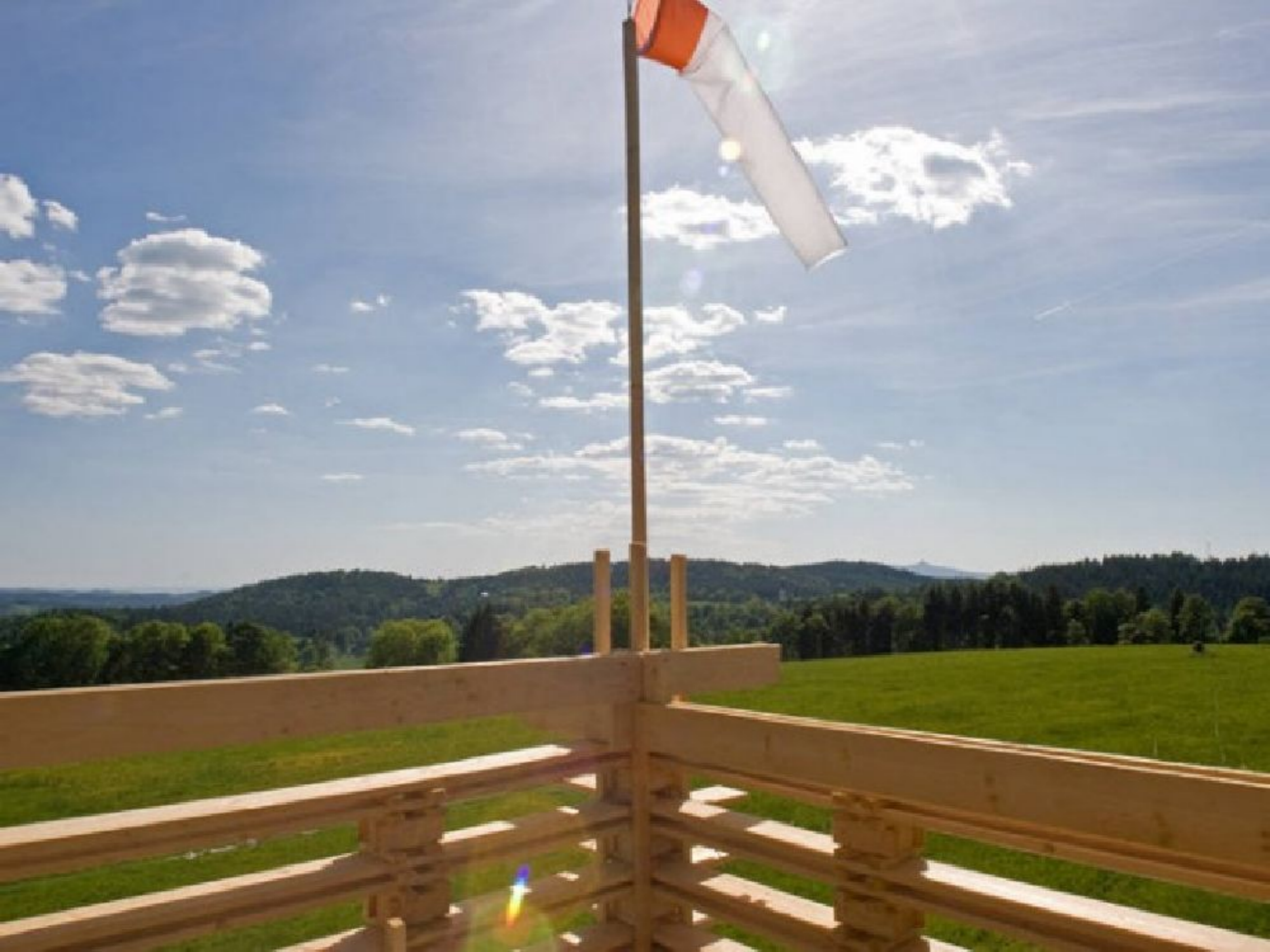









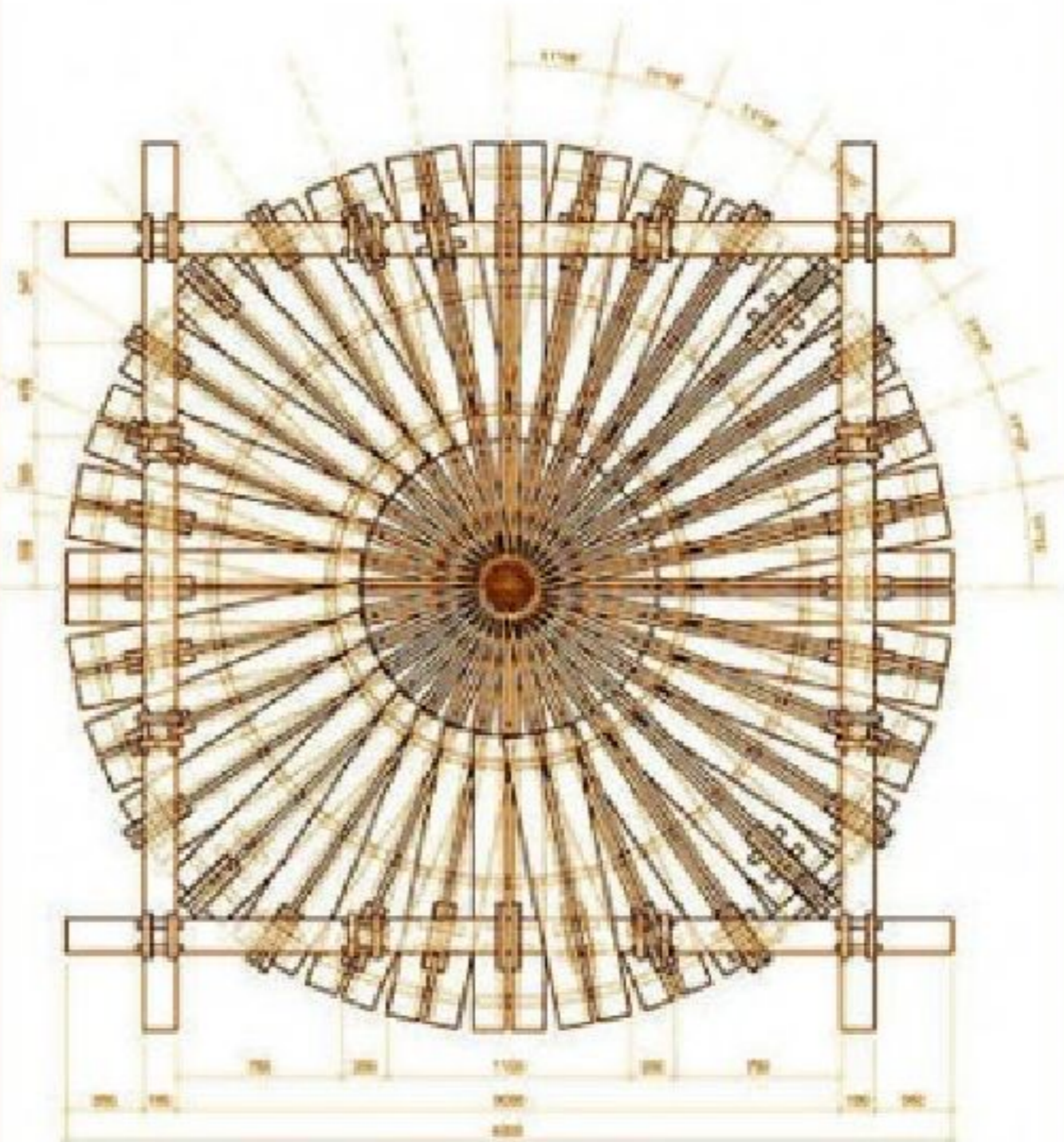
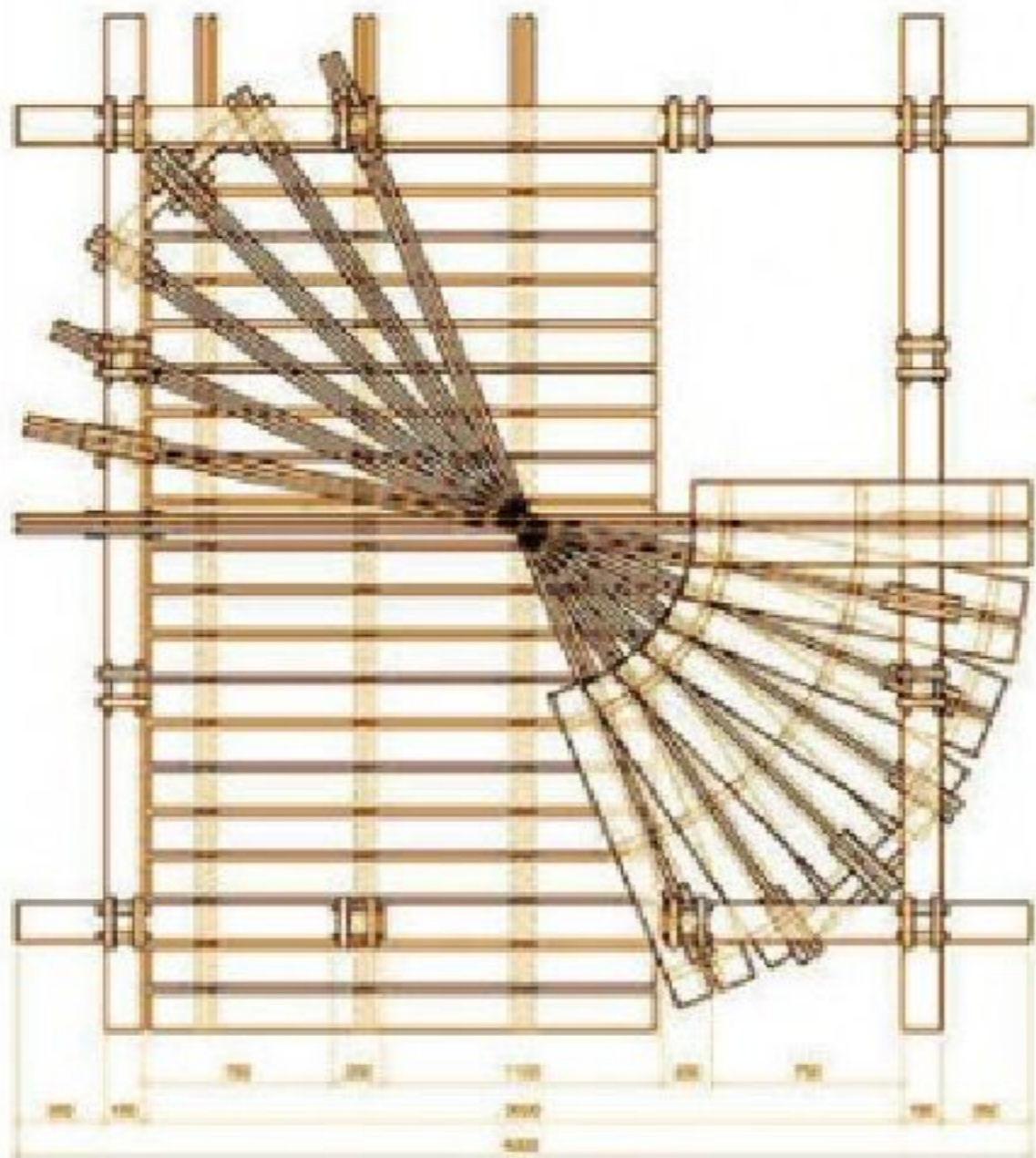

Název	Prototyp věže do Maxova - varianta 70 stupňů	Autor	E-mrak	Datum	09.01.06
Stupeň	Prováděcí projekt	Projektant	Jan Mach	Měřítko	1 : 25
Číslo	Půdorys nástupu, půdorys typický	Číslo		List	04

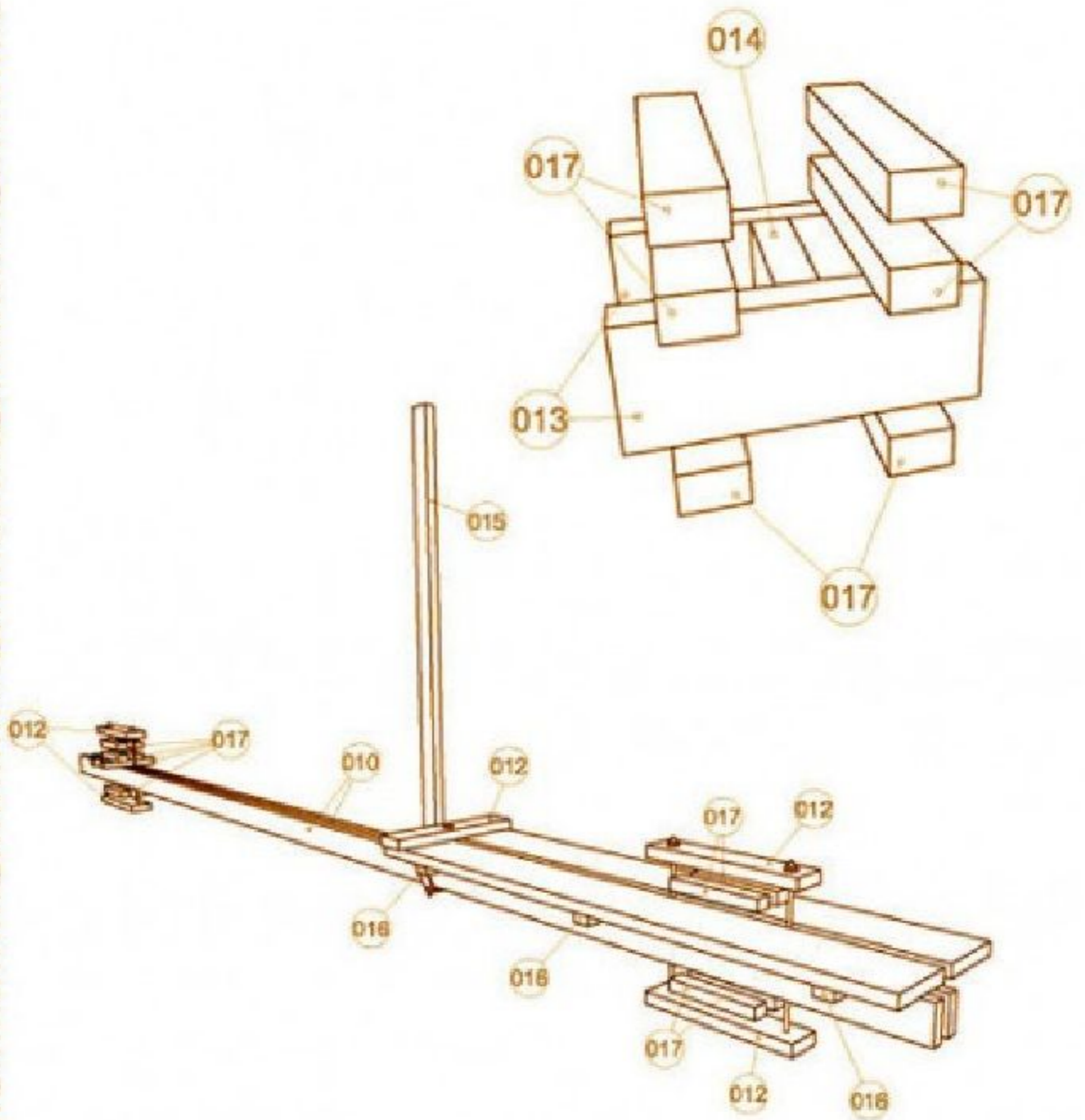
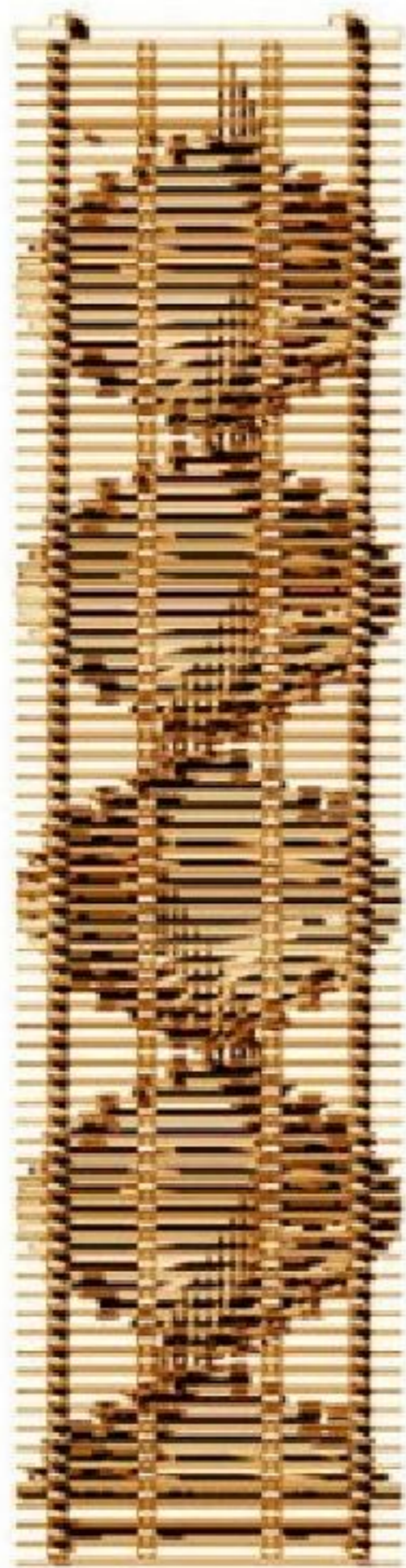





















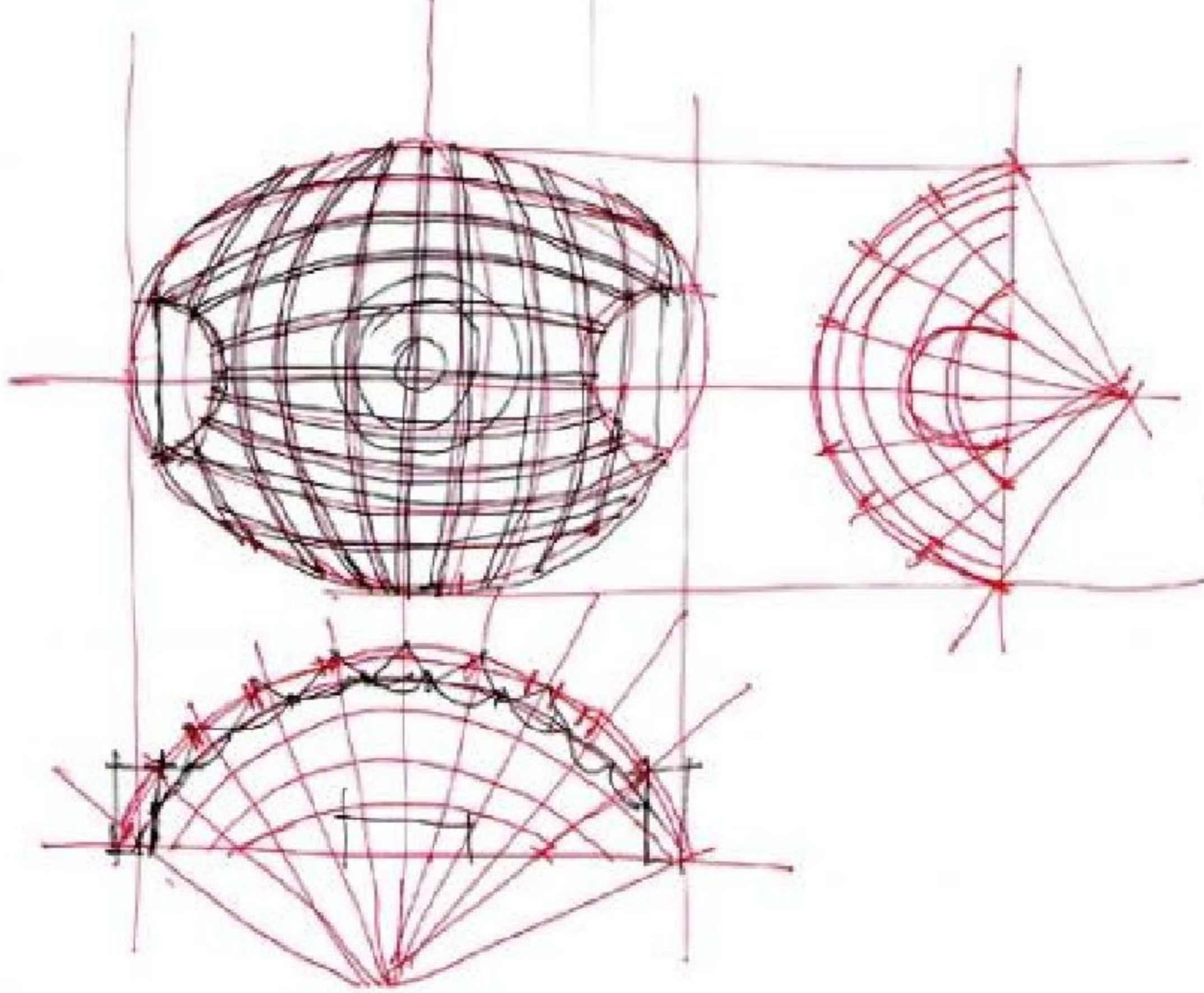







































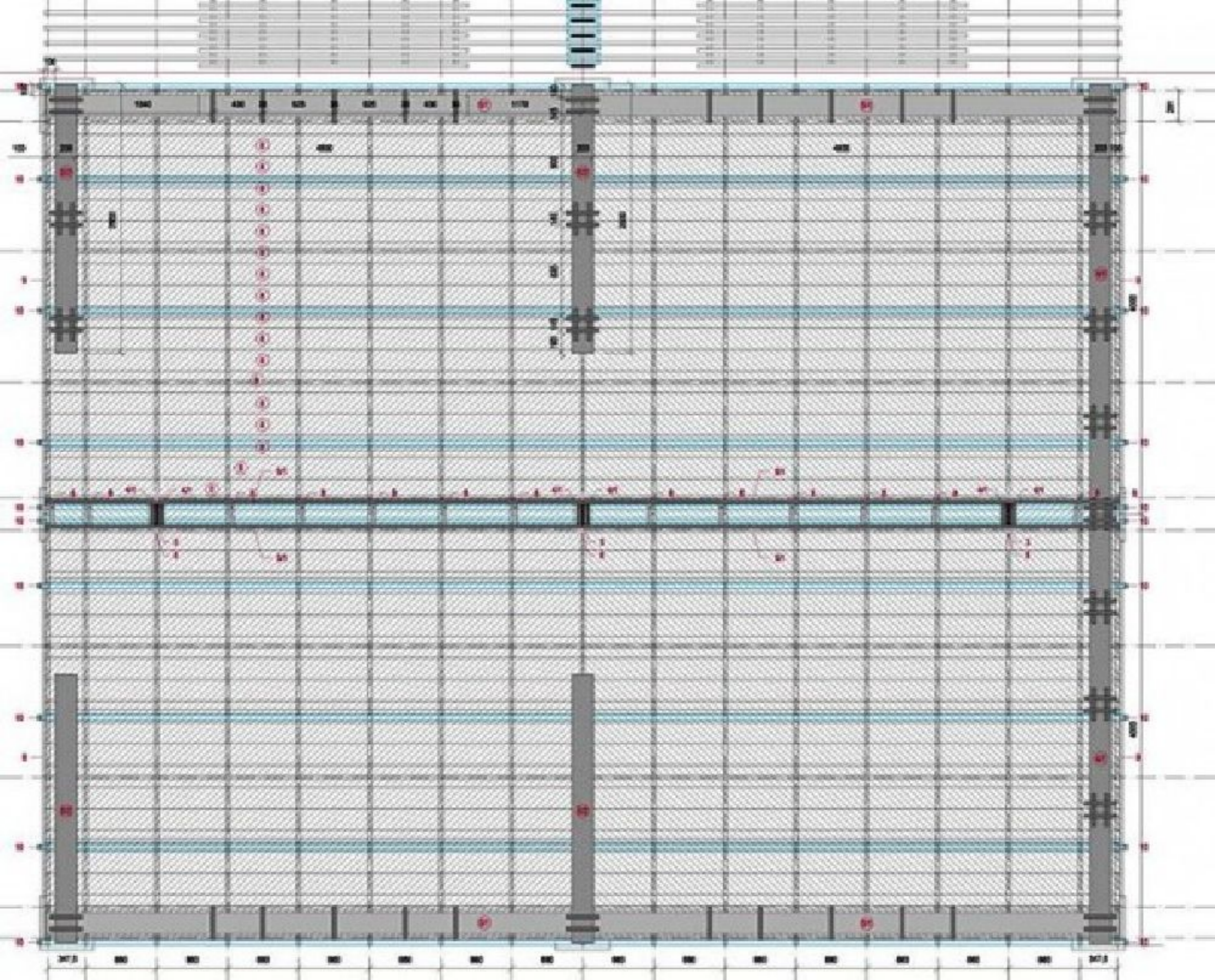

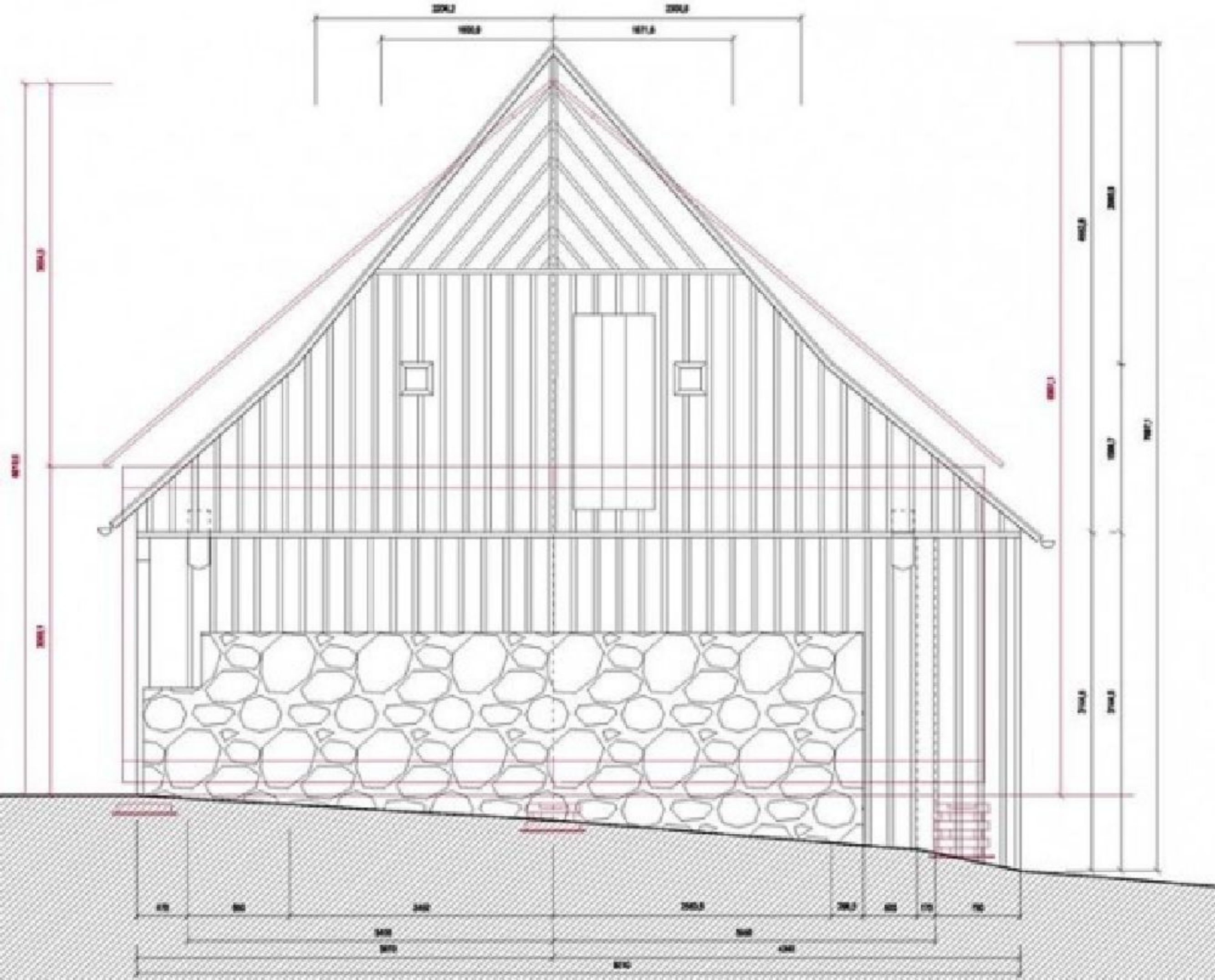

Масштаб: 1:20
Масштаб: 1:20

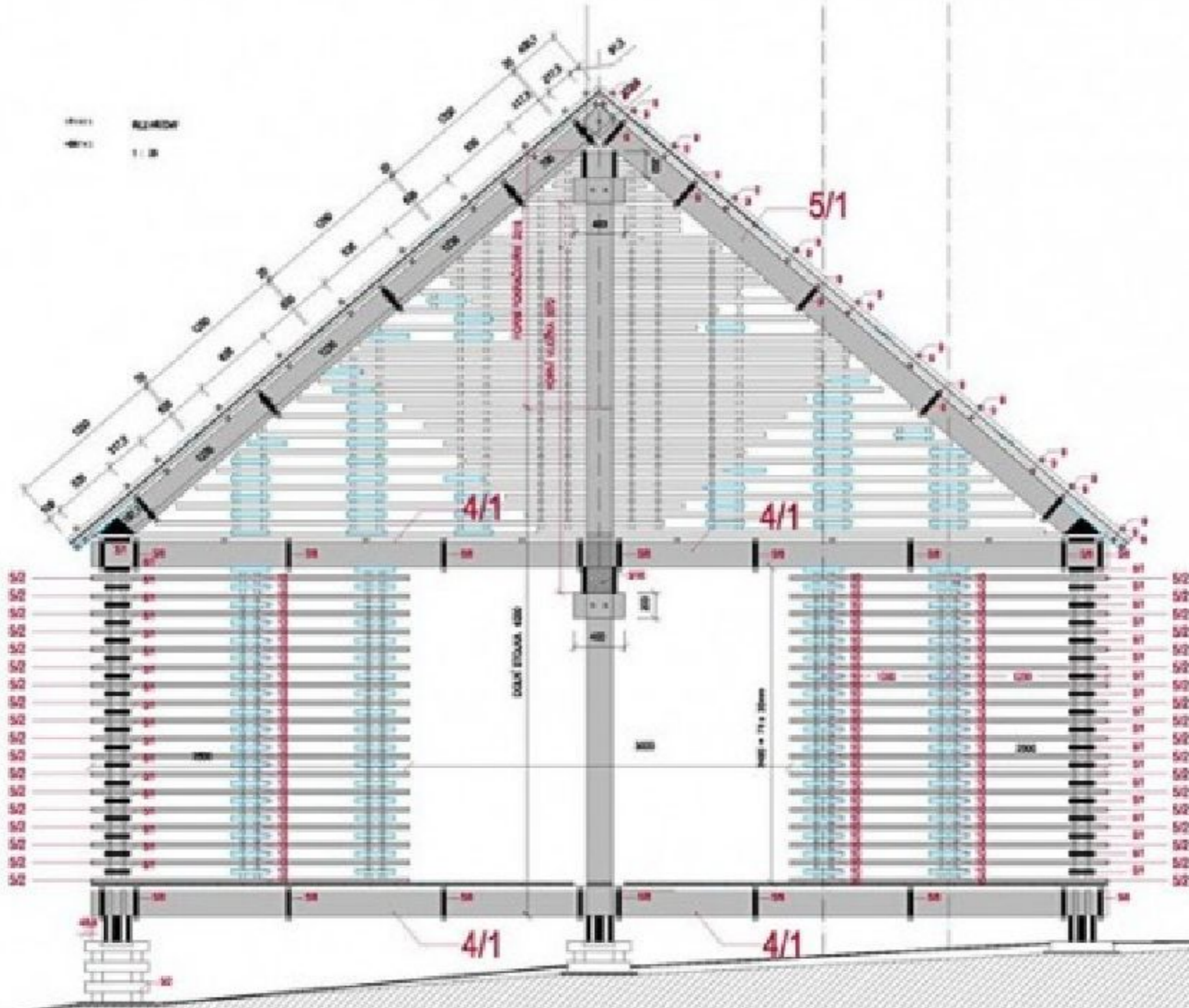

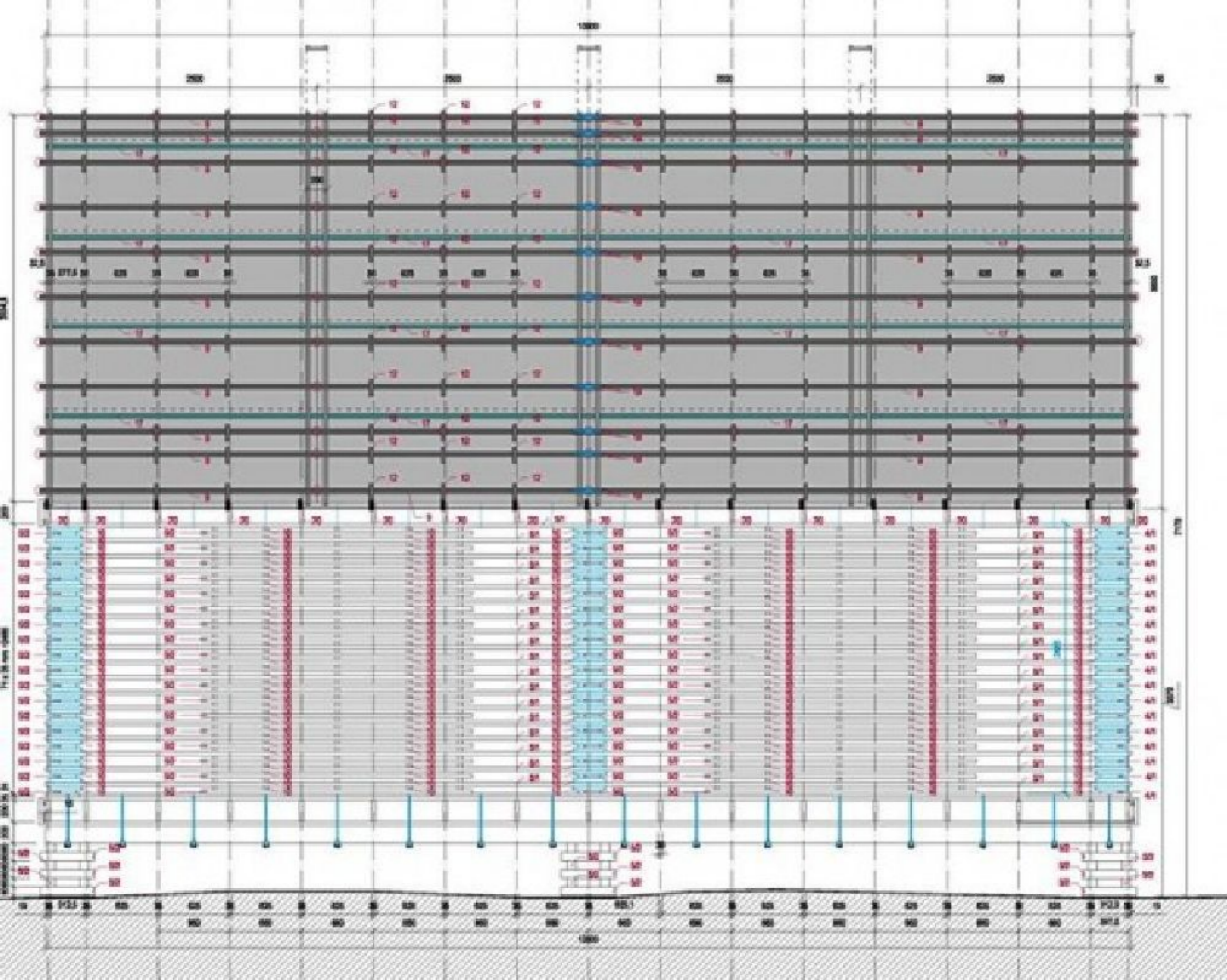

















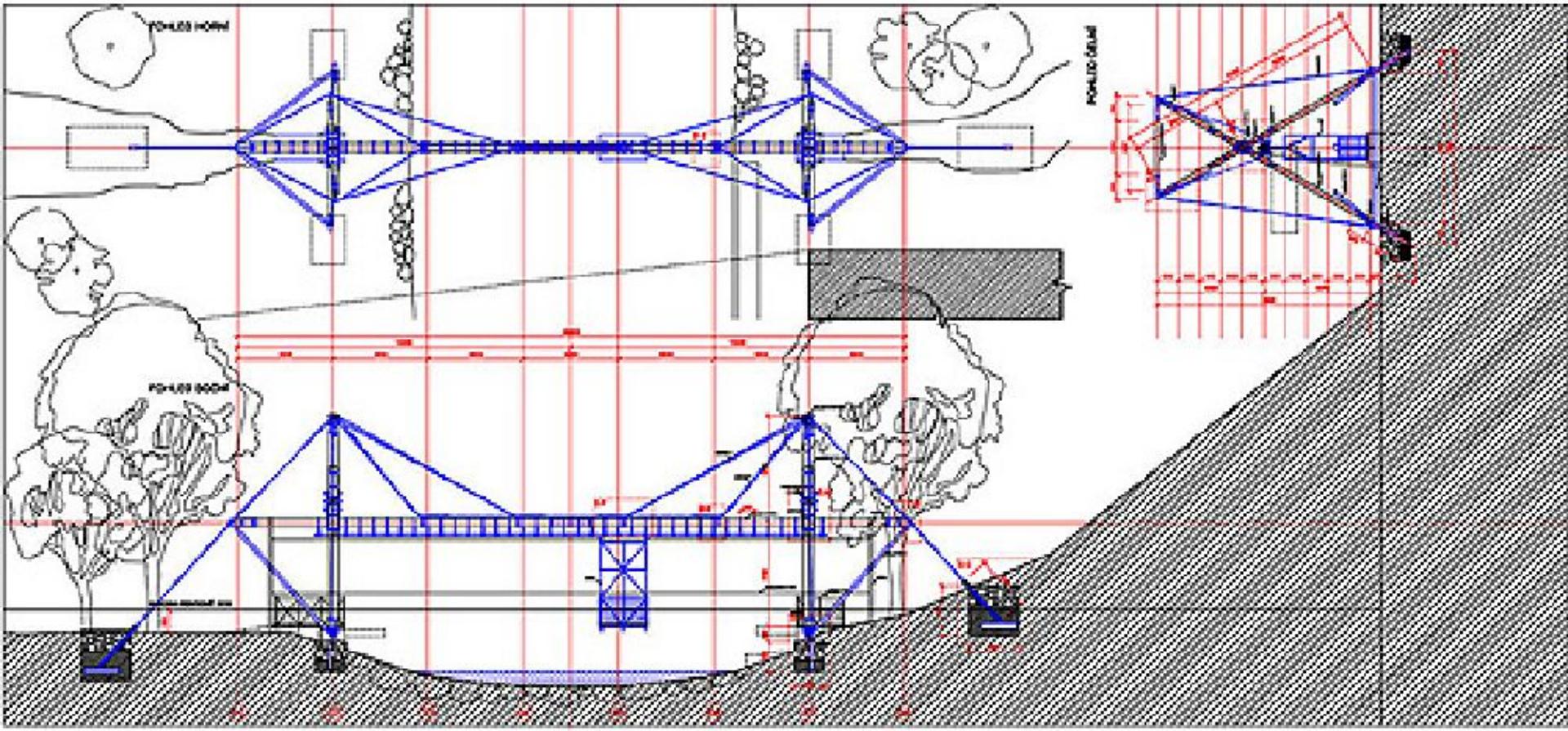















































































getto tamás





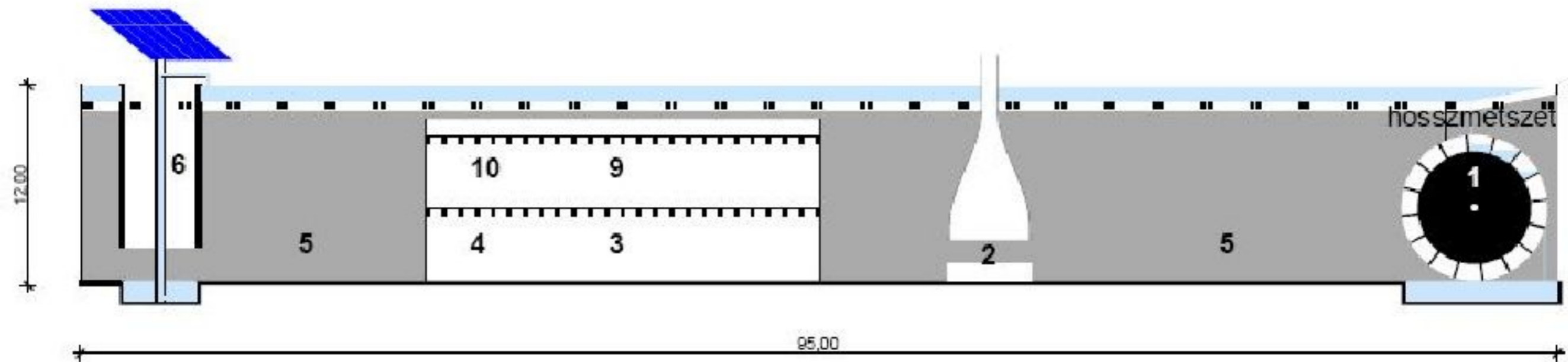

- 1 - malomkerék
- 2 - kemence
- 3 - konyha
- 4 - vizesblokk
- 5 - kiállító tér, előadó és művészeti tér
- 6 - napszivattyú
- 7 - malomárok
- 8 - búzamező
- 9 - konferencia - színháztér
- 10 - adminisztráció

alaprész











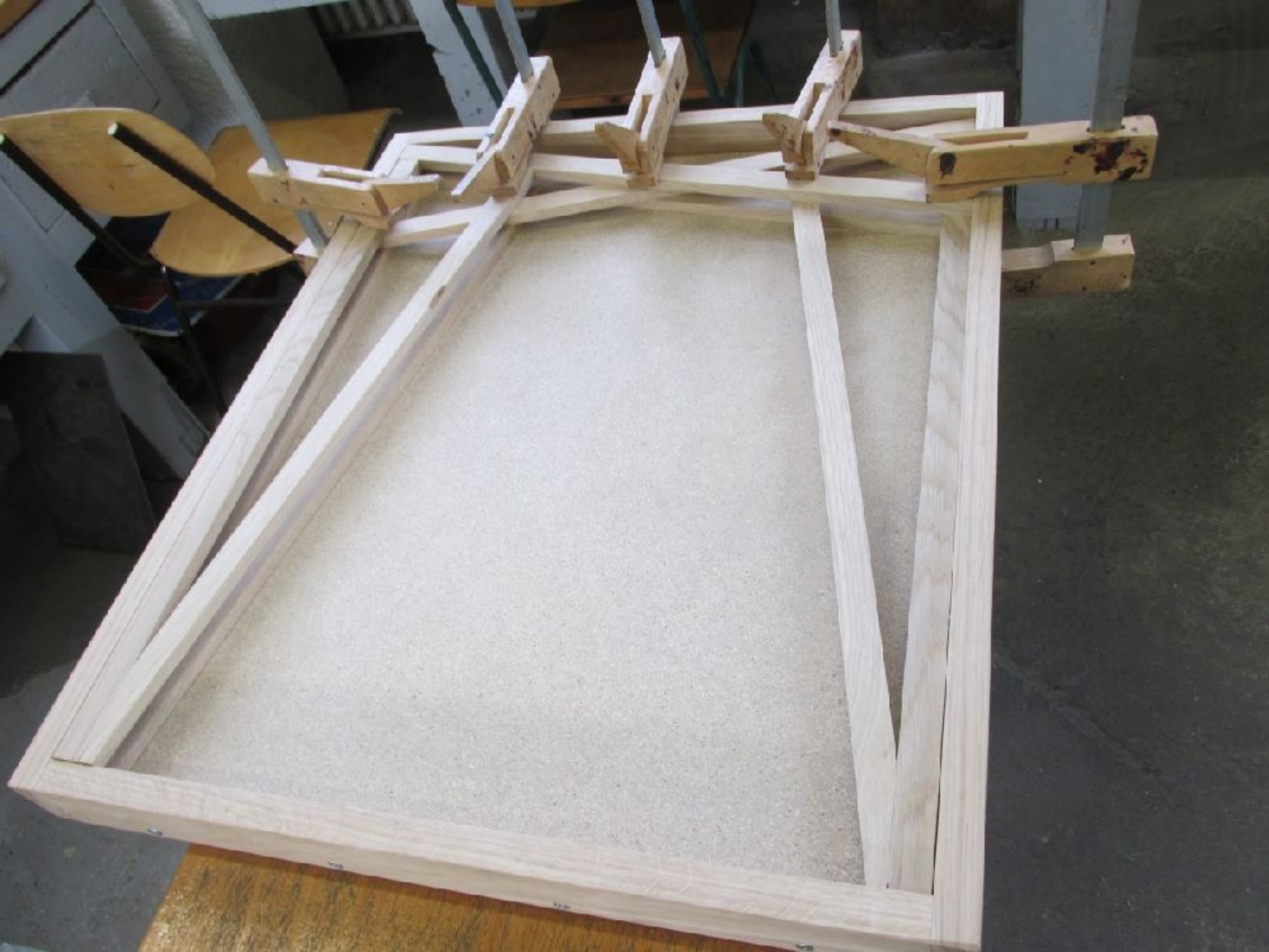



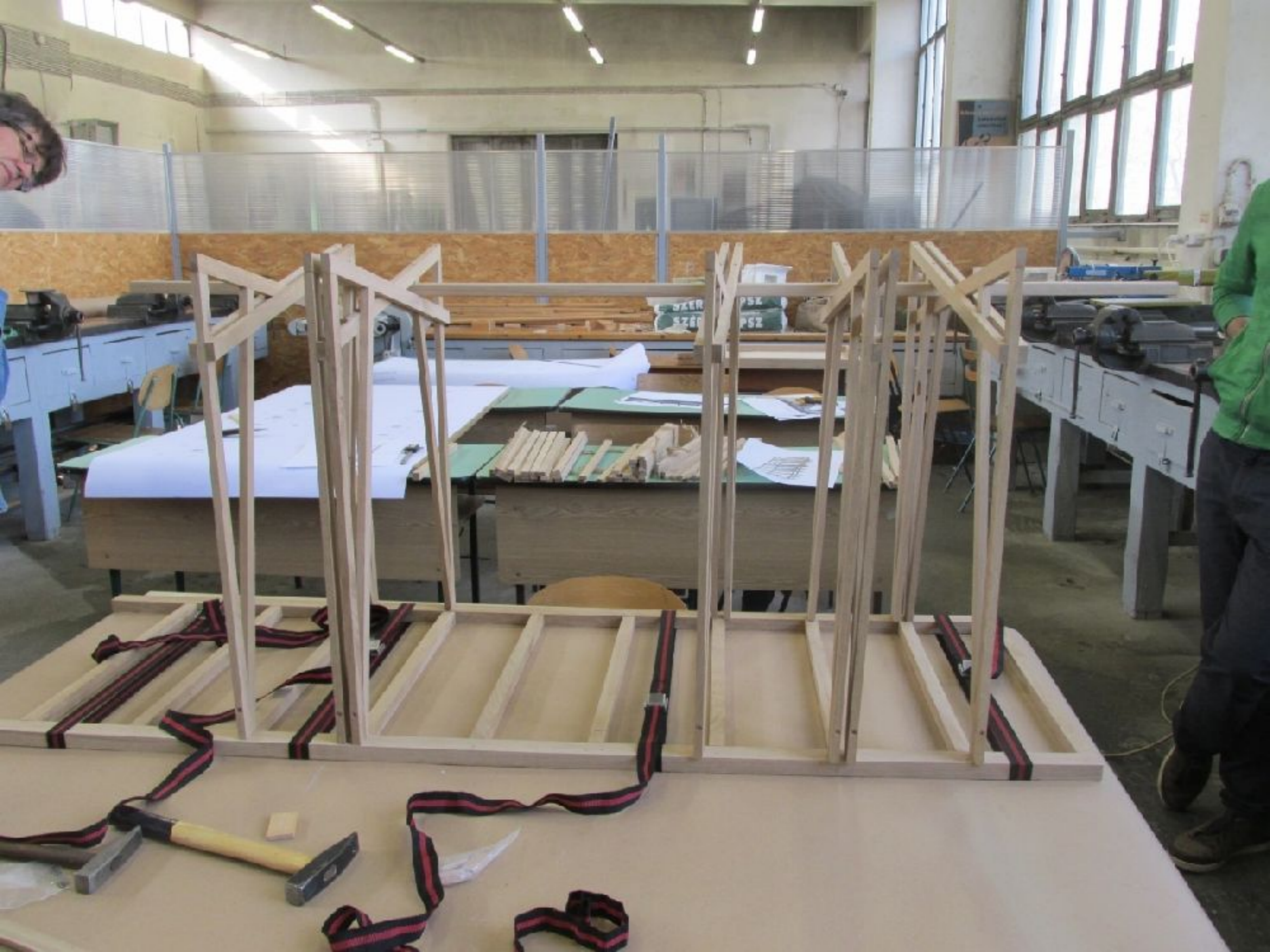







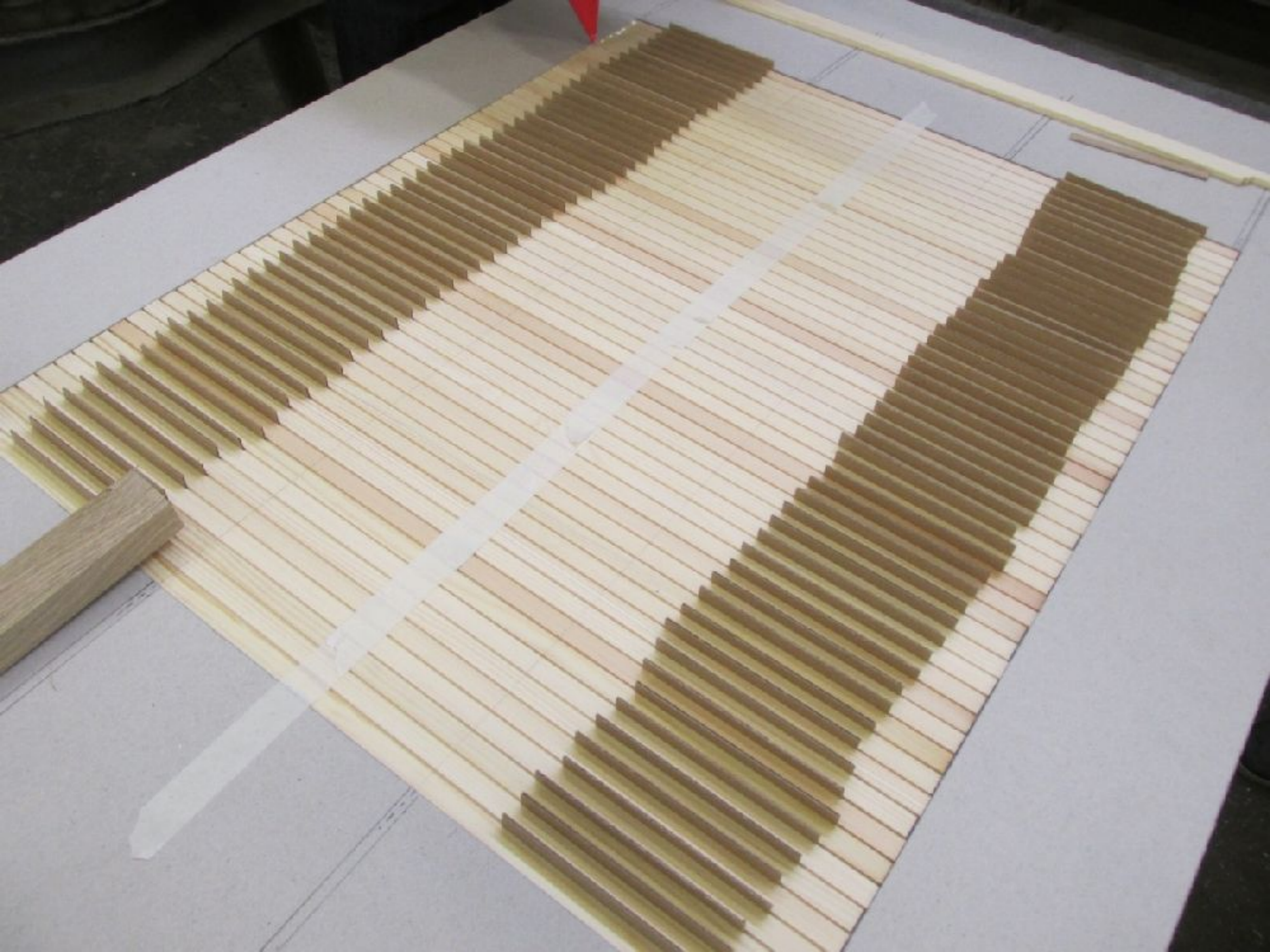























tech



buszmegállók















